

# Growing Cannabis In Complete Darkness

By 20'Thai

## Prelude

**I am about to outline a new concept that I have been working on now for a number of years and have finally been able to implement successfully in growing cannabis plants in a room without any light source what so ever.**

This can be done by using relatively inexpensive materials to create the device which provides the 'vital growing energies' that replace all photon emissions which plants normally require for photosynthesis.

This method will offer many advantages over the current methodologies of filling grow rooms with power draining heat emitting discharge tubes which are costly and consumable requiring regular replacement. This device requires **no energy** to run, **never** needs replacing, generates **no heat** at all, and costs about the same as one or two 1,000W HPS lamps and their running gear depending on how large a grow area one prefers to generate their personal stash. For commercial growing applications one must be aware that that largest sheet size I have tested the system to is 8 square feet and a height of 72". In reality with more materials and some fine tuning this surface area and height can be increased if one requires. Another enormous advantage this system has over conventional lighting arrays is that it produces the SAME growing energy in its' growing volume as the Sun does outdoors in the same given volume during the course of the day as the Sun tracks it's way across the sky. In that I mean that in the morning, whatever growing 'photosynthetic energy' that the Sun provides to a plant in the ground, this device provides the same amount within its growing volume. As the Sunlight grows in it's intensity leading up to midday and then tapers off leading to dusk, this device respectively provides almost the same amount of energy to its' grow volume indoors.

All we need to provide an apt growing environment indoors for our plant using this device is all the other conditions which we provide in a conventional grow room. All that is replaced is the light; ventilation, growing mediums, watering, fertilizing and temperature ranges all remain the same. Only the light is missing, or should I say, only the light is replaced in the total growing equation, everything else remains the same.

# Index

1. Preliminaries
2. What is Radionics?
3. How Radionics works
4. URLs to Radionic related internet sites
5. Experiment in radionics
  - a. and other extra sensory faculties
6. **Building a Radionics Plant Growing station**
7. **Growing Cannabis using a Radionics station**
8. Advantages of growing plants using Radionics
9. **Conclusion – Regarding Radionics**

## Preliminaries

There is Eloptic energy received from the sun constantly as the earth spins, taking care of Mother Nature and every living thing. You and I are intended to receive this energy on a daily basis getting as much as we need to stay healthy, and to share this with others who are in need, and to return the care back to Mother Nature by energies we consume and let off in a day to day living. The problem is that as our society has changed, we work indoors, we keep to ourselves, live in large cities, and many don't get enough energy to stay healthy.

The solution is right in your hands; you need more of nature's life giving energy. There are a number of ways to get it and I present a beneficial and energy efficient manner that can be done for all botanies requiring direct sunlight levels of energy to grow well at a modest cost, and it can last a life time once set up with very little and simple maintained.

### ***Plants are in a state of absolute fusion with their environment.***

When connected to audio monitors, plants behave<sup>1</sup> as '*extremely sensitive thermal, barometric, hydrologic, chemical, electromagnetic and ESP*' sensors. Responding to **every nuance of natural expression**, plants are sensory beings whose capacity exceeds the **expectations and understanding** of orthodox science.

Plants respond to energetic applications **not** normally detected in conventional measuring devices, because plants are living things, they are privy to biodynamic vectors which do **not** resolve into combinations of simple inert forces. In well controlled settings, plants evidence responses which are remarkably complex. In these responses, plants reveal themselves as **far more developed** beings than orthodox botany leads us to believe.



Botanists observe the absorptive-assimilative process in plants and **erroneously equate these with the life of plants**. They are sure that the nutritive requirements of plants are limited to mineral waters, carbon dioxide, and sunlight. Believing that plant life is the sum of these nutrients, orthodox botanists reject any experimental evidence of *life organizing energies*. The existence of such a '*vitalizing energy*' would displace these 'nutritive requirements' from their modern place as 'first cause', the latter being relegated to mere effects.

**Vested interests have been, are, and always will be a severe impediment to true progress within our societies, and the field of Botany is no exception to its privies.**

Modern Biology over quotes the phrase 'life comes from life', meaning by this that cellular reproduction is the generative agency in all life forms. It is for this reason that botanists believe that cellular absorptions and assimilations represent interactive processes which, in the absence of additional material, should operate continuously. The concept which cites cellular activity and cellular momentum as the life generative principle **fails** in several instances. Most obviously, such cellular momentum **fails to explain the death process**. Dr. Jagadis Bose showed that when plants are separated from their familiar grounds, they go into a state of 'shock', some eventually dying.

To continue with a little history, let us look at some of the most intriguing experiments which have shown the intimate relationship plants have with the vital energy of **ground currents**. *Dr. George Starr White* was one of the first to experiment with ground rods and plants. Running copper wires from a grounded copper rod into a series of potted plants, Dr. White found that this simple arrangement **greatly stimulated the life processes** of his test plants. Wired plants grew taller and flourished. It was remarked that these plants produced better foliage, **more beautiful flowers, and more succulent fruit**.

In addition, Dr. White dug irrigation ditches along tree rows, driving in 6 foot iron posts into the ditch every 15 feet. Thick copper wire was run between each of these ground rods and buried at a depth of 2 feet. This wire was pinched up underneath the root system of each tree and connected to the next ground rod of the sequence. In this way, all of the trees in a row were grounded through the copper wire. Plants in their natural setting receive a fixed ground current supply directly through their root systems. Dr. White, in his early investigations, established that metal grounds enhanced the life force in plants. His early experiments with natural earth currents revealed that plants need specific ground currents by which their life force is greatly magnified.

These remarkable results became the foundation of a new horticultural science. Dr. White adopted the method of wiring all kinds of plants to deep ground rods, discovering enormous improvements over traditional chemical manipulations. To improve the quality and strength of trees, for example, Dr. White placed single coils of 1 inch iron mesh completely around the trunks. Secured at a depth of four inches within the soil, these grounded coils stimulated the production of **stronger and more fruitful trees**. Dr. White tied plates of tin to the upper branches of his fruit trees, discovering that this procedure greatly increased the ground

drawn effects. He eventually found that the **storage of seeds in grounded iron boxes stimulated germination with an unprecedented vigor**. His work in therapeutic applications of these discoveries had already been demonstrated.

Georges Lahovsky later made contributions in this new and exciting field of study, focusing all of his attentions on the effect of resonant loop therapies. Placing opened metallic loops a few inches off the ground around plants, he found that plants which suffered from various ailments **were suddenly and completely cured**. Eliminating the need for most of the insecticides and other chemical poisons normally applied in such instances, Lahovsky pioneered a natural method of medical therapy in human subjects. Long before he conceived of the multiple wave oscillators, a device which irritates its subjects with an electrostatic barrage, he worked with the naturopathic energies of these "open circuit" loops.



# What Is Radionics?

Radionics is the utilization of an unusual energy or energies in devices to produce natural phenomenon or effects. Radionics has as its basis the following:

There is an energy pervading the universe that has unusual properties and may be used for the betterment of mankind. Under certain conditions, this energy has been found to affect man or his environment and can be controlled under conditions imposed by the characteristics of that energy.

As in all sciences, development of that science is made through observation of properties or characteristics of that which is studied. Experimentation follows observations in order to control or induce the phenomenon itself in a controlled manner.

There are two reasons 'why' the USA has made 'laws' against Radionics.

1. It works, but not in a way totally understood, not by the academic community and nor by the practitioners.
2. It works and produces miracle cures in man, plants, animals, and outdates existing sciences if it is understood. Therefore, the 'lobbies' in Washington representing the commercial applications of existing sciences force laws against Radionics to preserve existing sciences and the large sums of money invested in them to create our present technology and preserve the jobs of millions which might be lost if indeed Radionics was used to achieve the same results.

## Radionics Stations





## How it Works

Every point in space and time has a unique vibratory rate of resonance. When an object matches that particular vibratory rate, there is an instantaneous resonant connection which allows for a plethora of normal and seemingly paranormal events to occur. When one knows the vibratory rate of a specific person they can send a healing signal to them by matching that 'healing rate and transmitting energy' required. The vibratory rate of a person, place, or thing is determined by accessing their frequency via a photo, name, or personal object; Radionic tuning can be done by device or by the trained human mind (*multiple mentalism*<sup>2</sup> gives the human mind ability to focus on several aspects of the same space-time event at once as opposed to mechanical tuning with a Radionic device).

In the field of holistic healing and medicine, the Radionic Association in Oxford, England has this definition of how radionics works to heal a sick human being, quoted verbatim:

"It is a method of healing at a distance through the medium of an instrument using the Extra Sensory faculty. In this way, a trained and competent practitioner can discover the cause of disease within any living system, be it a human being, an animal, a plant or the soil itself. Suitable therapeutic energies can then be made available to the patient to help restore optimum health. Radionics was originated by a distinguished American physician, **Doctor Albert Abrams (1863 - 1924) of San Francisco**, and it has been developed by numerous other research workers and exponents including Ruth Drown, George de la Warr, T. Galen Hieronymus, Malcolm Rae and David Tansley. Basic to Radionic theory and practice is the concept that man and all other life forms share a common ground in that they are submerged in the electro-magnetic energy field of the earth; and further, that each life form has its own electromagnetic field which, if sufficiently distorted, will automatically end disease of the organism. Accepting that "all is energy", Radionics sees organs, diseases and remedies as having their own particular frequency or vibration.

These factors can be expressed in numerical values which are known in Radionics as 'rates', and Radionic instruments are provided with calibrated dials on which such 'rates' are set for analysis and treatment purposes. The Radionic practitioner, in making his analysis, uses the principle of dowsing by applying his faculty of extra sensory perception to the problem of detecting disease in much the same way that the dowser detects the location of water, oil or mineral deposits. The particular form of Extra Sensory faculty used in Radionics is often referred to as '**the radiesthetic faculty**' through which the practitioner, by means of a series of mentally posed questions, obtains information about the health of his patients to which **the conscious thinking mind has no direct access.**"

## URLs to Radionic related internet sites

<http://www.raydionics.com/>  
<http://www.brantridgeuniversity.edu/index.htm>  
[http://www.radioalchymy.com/listen/121803\\_listen.php](http://www.radioalchymy.com/listen/121803_listen.php)  
<http://www.radionic.co.uk/>  
<http://hometown.aol.com/rdawnrobert/page1.html>  
<http://www.radionicsmagic.com/>  
<http://www.hscti.com/>  
[http://www.geocities.com/c\\_cosimano/psionics.html](http://www.geocities.com/c_cosimano/psionics.html)  
<http://www.myholistichealthshop.com/radionics.html>  
<http://www.theradionic.com/>  
[http://www.procaduceo.com/en\\_tools/...ic/radionic.htm](http://www.procaduceo.com/en_tools/...ic/radionic.htm)  
[http://www.geocities.com/alchemical\\_homeopathy/](http://www.geocities.com/alchemical_homeopathy/)  
<http://www.se-5.com/se5.htm>  
<http://www.remedydevices.com/>  
<http://home.earthlink.net/~cj31/>  
<http://www.bioenergeticmedicine.org/radionics.htm>  
<http://www.radionicsinstitute.com/>  
<http://www.copenlabs.com/radionics.htm>  
<http://www.nexusmagazine.com/articles/franks.html>  
<http://members.austarmetro.com.au/~hubbca/radionics.htm>  
<http://www.prosperity.com/radionics/>  
<http://educate-yourself.org/tjc/rut...toldstory.shtml>  
<http://www.sniggle.net/drown.php>  
<http://www.radionics-software.com/>  
<http://www.scanningunlimited.com/>  
<http://www.drbeans.com/SVI.html>  
<http://www.sdanet.org/atissue/books/dowsing/d02b.htm>  
<http://thesevenrays.topcities.com/H...OfRadionics.htm>  
<http://www.radionicarv.com.ar/inicio.htm>  
<http://www.algonet.se/~johnnyfg/dow...arkv/manual.htm>  
[http://www.stoneage.co.uk/acatalog/...ndulums\\_19.html](http://www.stoneage.co.uk/acatalog/...ndulums_19.html)  
[http://www.oxygenresearch.com/oxybliss/index\\_flash.html](http://www.oxygenresearch.com/oxybliss/index_flash.html)  
[http://www.nicko500.co.uk/radionics...n\\_resources.htm](http://www.nicko500.co.uk/radionics...n_resources.htm)  
<http://forums.orgonite.com/>  
<http://www.psychotronics.org/index.htm>  
<http://www.amasci.com/weird/wsci.html#rad>  
<http://www.mcgurk-electrical.co.uk/index.htm>  
<http://www.reiki-seichem.com/radionics.html>  
<http://www.borderlands.com/main1.htm>  
<http://www.sulisinstruments.com/index.htm>  
<http://www.emeraldinnovations.co.uk/radionic/>  
<http://www.energeticmatrix.co.uk/el...chomeopathy.htm>  
<http://www.xtrememind.com/forum/index.php?showforum=10>  
<http://www.crystaltiger.com/sa04000.htm>  
<http://www.emeraldinnovations.co.uk/radionic/index.html>

In case any of the above URLs are relocated to a new address, feel free to use the URL facility below to obtain their new address:

<http://www.archive.org/index.php>

## **Experiment on Radionics – by C. Alon**

Plants absorb gases and mineral waters only because they are biodynamically activated by an external energy. These studies and others show that plants function because they first absorb Radionic currents from the ground and from space. Vegetative life functions all but cease in the absence of Radionic currents. In this vantage, we study the processes which precede plant metabolism. Indeed, we will learn that the Radionic earth currents comprise the fundamental nutritive need of plants. We will therefore focus attention on the energetic precursors to plant life, the Radionic currents which raise vegetative forms up from mineral matter. In this series of experiments, we will use plants as objective detectors of subjective energies. Plants themselves will prove the objective reality of Radionic ground currents.

### **DETERMINING THE RADIONIC SELECTIVITY OF PLANTS**

#### **MATERIALS:**

- 1 or more Micronta Biosensors (Radio Shack)\*
- 2 Extension wires with soldered copper electrodes
- Several plants
- Large plastic drinking cups
- Ringstand with rubberized clamp
- 1 - 2" C-clamp
- Copper ground rod
- Several stage variable capacitor (medium to large volume)
- Long extension wires
- Wire stripper



## PREPARATIONS

Although my last article contained some of this preliminary information, many have requested further elucidation on the preparatory methods necessary for these experiments.

You will need to obtain several Biosensor devices for comparative studies among plants (see editor's note). The Biosensor changes galvanic skin response to audio fluctuations. Once you make the necessary modifications on your Biosensors for plant experiments, they will not be very useful for personal biofeedback readings.

For plant experiments, the electrodes must be well exposed and unencumbered. There are several ways to contact the leaf tissue, but by far the best means uses the stainless steel electrodes in the finger pads. To expose them completely for plant experiments, carefully clip the Velcro bands around the electrodes. DO NOT CUT the lead wires at any point! Carefully trim away the material around the electrodes.

The ringstand you have chosen MUST be equipped with rubberized clamps if you are going to use the clamps to attach directly to the electrodes. These will hold the electrodes to the plant leaves without shorting out the Biosensor. The best way to attach the electrodes to the plant is with a small two inch C-clamp. This clamp will fit snugly in the clamp of the ringstand and will provide for greater ease of applying the sensitive amounts of pressure required by the electrodes. You will need to insulate the contact points of the C-clamp from the electrodes, and this can be done with any type of cloth tape.

Another means by which we may contact plant tissue requires two small copper alligator clips (obtained from Radio Shack) and two extension wires. Simply clip off the electrodes and solder the wires to the Biosensor leads. Then solder the clips to the ends of these extension leads. Cover the solder points with electrical tape. These clips must be closely placed side by side on the leaf. This method contacts plant sensitivities along the veins of the plant, and always requires a higher gain setting before the audio signals register. While this is not the most preferred contact format, it does permit certain other freedoms. When contacting leaf tissue with alligator clips, one must make absolutely sure that the leads cannot and do not move! The leads must be supported against gravity. Any movement will invalidate your findings.

You may wish to use several plants for the experiment. Select different varieties. These may be purchased or, better yet, taken from the ground nearby. Wildflowers have proven to be excellent specimens for these experiments. I have found that large plastic cups serve well as insulated containers. Place your plants in these if you have decided to use wildflowers. Water the leaves and roots well, and allow at least a week for the plant to acclimate to its new home.

As we are going to implement energies from a ground source, make sure you set up your experimental arrangement near the source of your choice. If you have chosen to use a ground rod, make sure that there is a window which can access the long lead wire. Set the arrangement on a sturdy table with adequate access to the lead wire from ground. Several of our readers may not have the necessary proximity to ground which they would like. In some cases, an ordinary water faucet ground has been found to be equally effective. Cold water pipes are good sources of ground currents.

Loop the stripped end of a long wire to either your ground rod or the cold tap of your kitchen sink. Make sure there is enough stripped metal surface in contact with your ground source. If you use a ground rod, try using a copper conduit pipe. These can be obtained for a few dollars in any hardware store. Get a 2 foot section. Wet the ground you have chosen for your site. Wearing gloves carefully drive the pipe into the ground until about 9 inches remain above the surface. Strip the free end of your lead wire and wrap this wire around the pipe. Use electrical tape to hold the wire firmly in place.

If you are using a kitchen sink, simply strip the free end of a wire and wrap it around the base of the cold water tap. Wrap with rubber tape and draw the wire up to your experimental arrangement. You are now ready to begin the experiments.

## **EXPERIMENT 1**

Before we begin to use our plants, or attach the tuning capacitor, there are several key items with which you should become experientially familiar. The ground line is electrically neutral. Electrical measuring instruments require two comparative connection points. We cannot measure or define an electrical potential from this monopolar wire, since this procedure requires another ground reference. Using two copper ground rods or two cold water pipes results in electrical zero readings. One might as well connect a galvanometer to itself!

The energy is not electrical. Neither is it electrostatic. Tests with electroscopes do not show any deflection. In addition, those who declare these currents are produced by either power lines or radio signals will be disappointed! It has been found that these energies flow through components which rectify all such electrical currents. Electrically neutral wires, prepared to exclude all interferences, stimulate surprisingly powerful responses in biomonitored plants. Therefore, the grounded wire is electrically neutral but is not energetically neutral.

Ground currents have certain characteristics which differ completely from those of electrical currents. Electricity will flow between any two points of different potential. Ground currents will not always flow between two points of differing electrical potential. Ground currents are biodynamic currents, one of whose attributes consists of patterns. Ground currents will flow



only when a capacity to absorb certain patterns is present. In the absence of these patterns, no current will flow. Hence, no current may initially be detected or sensed. It is the "pattern demand" which stimulates the flow of ground currents — an attribute not shared by electrical currents.

Each person has specific "pattern demands" for Radionic currents. This is evidence of differences in human condition, not evidence that Radionic currents do not objectively exist! There are those who do not comprehend how an energized line can produce no effect in certain people. Radionic ground currents are potentials which must find capacities for their patterns in order to flow. If the proper pattern demanding capacities are present in us, then we will feel the energy. If these pattern demanding capacities are not present within us, no Radionic energy will flow and we will feel nothing. The line will appear to be "dead". But this does not mean that we are insensitive, or that Radionic energy does not exist!

Whether you have or do not have a pattern demand which the ground line can supply has nothing to do with your own sensitivity or the existence of Radionic energy. These are unique to individuals and represent nutritive differences. Many of our food preferences actually come from a deeper nutritive need. It is the same with Radionic currents in the ground. The selection process represents a deep truth which has rarely been examined.

Hold the wire in either hand. Relax and notice what you are sensing. Can you feel the energy? Some sensitive persons can. This energy is not disagreeable. It is in fact vitalizing; hence the term "Vital Energy". Some feel this influence as a tingling in the fingers and arm. Some feel it as a heat. There are other effects, those which involve our higher states of awareness, but these visceral sensations will now suffice in discussion. With certain persons, these sensations will penetrate the thorax or abdomen quite strongly. If you are feeling or sensing the energetic flow, you are observing the action of a personal "selection process". Your body is selectively absorbing a certain Radionic current from the supply. This is why YOU feel its presence.

But the sensations differ among experimenters. You may not feel a thing, and this is certainly not your "fault" or "inability". It is simply indicative of the fact that YOUR body is not selecting any of the Radionic currents from the ground supply at that moment. It is because your body has not selected a Radionic current from the supply that you feel nothing. These demands are autonomic, having nothing to do with will power, concentration, talent, or self worth. They simply indicate the differences in our personal organization. Do not hastily conclude that the energy does not exist, or that the line is incapable of delivering energies for our experiments with plants. Worse, you should not conclude that the energy requires your mind, or that it is a self-produced effect. These are some of the fatal flaws which orthodox science have historically made.

Wide differences always exist among wide varieties of people who test for Radionic currents. The reason for these wide variations has to do with personal selectivity. The specific currents which our bodies demand and receive do not always coincide with those experienced by



others. Hence the differences in "tingling", "heat", etc. sensations. Each effect is actually caused by a different vitalizing current, the direct result of autonomic personal pattern demands.

The fact that there are such selective differences among people represents yet another phenomenon which should provoke our curiosity. Why do some people not select specific sensible currents from the ground supply? Why do others select sensible currents? What do these manifestations teach us about our different body needs? All of this has to do with our individual differences. This fact leads us to add phenomena, not eliminate them, when compiling data in Qualitative Science.

## EXPERIMENT 2

In the first experiment, you have already learned a fact which has troubled orthodox science for over two centuries. The fact that only certain persons were able to detect the vital currents caused the academicians to invalidate the existence of vital energy. The addition of a variable capacitor to the ground wire brings an aspect of tuning into our experiment not present in the first experiment. The variable capacitor stimulates the appearance of currents which may not have moved through direct body contact alone. We may think of the variable capacitor as a pattern demand which exceeds those within our own bodies. The variable capacitor thus reaches into the ground supply and stimulates the upwelling of currents which respond to its pattern demands. These new currents were not present when you simply held the wire in your hand.

The parts list does not require any specific variable capacitor, simply because any medium to large volume multivane rotor will suffice. These are inexpensive, and can be readily obtained through several companies (Antique Electronics 1-602-820-5411 or Fair Radio 1-419-223-2196). Buy several different sizes if you can. These will each produce their specific pattern drawing results, a phenomenon which itself requires deep study. With the use of the variable capacitor we are effectively increasing the supply of special pattern currents. This increases the possibility that you may now feel them, had you not previously.

Locate the terminal which connects with the STATOR plates of your variable capacitor. This is always an insulated terminal on the side of the frame. Connect the ground wire to this insulated terminal. Ground energy enters the stator and floods the capacitor gaps. We want to introduce new pattern capacity to this incoming flow. Turning the rotor achieves this condition. The resulting currents must be withdrawn from the capacitor. Connect a thin wire lead 6 feet in length directly to the frame of the capacitor. It is important to use a thin wire here, since we will disconnect this wire during certain experiments, and we do not wish to move the plants at all. Thick wire leads prove too unmanageable for delicate movements.

The variable capacitor and its long thin lead wire is the tunable energy source for your experiments. Flowing across and through the vane spaces in their own distributed patterns, each current will manifest its maximum flow at a specific rotor position. When you turn the rotor, you are now selecting specific Radionic currents, some of which you may feel with a special vitalizing force. Open the rotor completely. Hold the wire in your right hand. Now slowly turn the rotor until you feel the current. Note those positions on the rotor where you have sensed the energizing current. You may wish to use a protractor in order to write the degree of turn at which you felt the effect. This process is like the application of Radionic Energy in therapy, a topic of greatest interest and need today.

The conventional attitude, including those who hold to the "psychotronics" theory, is that the reception of these energizing currents is a completely subjective phenomenon. Through the use of your plant sensors, you are about to discover that Radionic Currents are objective and real. In their autonomic demand for Radionic currents, plants are no different than us. The demand for these currents is the demand for life-giving energy, a vitalizing flow which revivifies the entire physiology through contact. Note the very form and symmetry of the autonomic nervous system. Does it not resemble the complex weave of vines or roots? In our autonomic demands we are very vegetative in process.

More fundamentally, this demonstration upsets several conventional theoretical foundations. Having connected the plants through a variable capacitor, we have greatly complicated the "electrical" view of vital energies for obvious reasons. How does this energy flow through the space gaps between the vanes? Those who reduce these influences to electrostatic fields or high frequency currents are soon baffled by the experimental conditions imposed on this simple system. Placing resistors and blocking diodes in line with ground demonstrably breaks any radio energy which may find itself into the line. Nevertheless, the Radionic energies continue flowing.

### **EXPERIMENT 3**

Leave the rotor completely opened now. You are now ready for the second phase of our experiments. We will now connect your plants with the ground source. Draw the thin six foot lead wire from your tuning capacitor, keeping the capacitor far from the plants which you will examine. It is **IMPERATIVE** that the plants be kept at a good distance from the tuning capacitor. Certain effects we will want to elicit require that this separation distance be maintained. Place one of your plants on one side of the ringstand. Select a leaf. Place the electrodes on opposite sides of the leaf and slip this arrangement into the C-clamp jaws. Carefully close the clamp around the electrodes. Gently adjust the pressure while tightening the clamp. Be careful **NOT TO PIERCE THE LEAF TISSUE!**

Turn on the Biosensor and adjust the sensitivity knob. Slowly turn the dial until a steady tone is obtained. You will note that the responses are erratic, either pitching down or up. You



want to balance this tone until it remains constant. Do you hear the "plant songs"? Unattended, this plant is crying out to the environment. In natural settings, these sounds cannot be heard, as they are vitality signals.

Remember, these audio signals are not electrical in their primary state. It is the interaction of the Biosensor current with this vital plant energy which produces the undulations. Listen and observe the wandering of the plant song until you have grown accustomed to the sound.

Now take the wire lead from your variable capacitor, the very same lead which you grasped in our second experiment. Drive the free end of your lead wire directly INTO THE ROOT SYSTEM of your plant. You have before you a most remarkable "triode", the plant acting as an exchange medium between vitality energies and the audio signaling device. In this, we have actually devised an objective instrument for the detection of otherwise subjective energies. Begin with the capacitor in the "opened" position. Reestablish your audio baseline by adjusting the sensitivity on your Biosensor. Let the plant become accustomed to the new condition. If you have two plants connected at the same time to different Biosensors, you can compare the audio differences produced by an unattached plant and this new attached state.

The plant may actually begin its wild fluctuations with the first placement of the wire. This means that the opened capacitor position has successfully drawn in a pattern which the plant has demanded. We can begin our search now. Very gradually close the vanes. Gradual movement is the key in this experiment, since plants are not "on-off switches". Being living systems, they require time to respond. Plant responses always reveal a latency period just before and after their audio response. In turning the dial slowly you will hear several pitches "stutters". Each represents a Radionic current which the capacitor has entuned. Listen for these obvious audio changes. Whenever you hear an audio "stutter", you have "located" a current. These experiments objectively prove the reality of Radionic instrumentation and points at which specific Radionic currents seem clustered.

In their highly developed and behavioral responses to Radionic currents, plants evidence a complexity which requires developed neurological structures, yet we cannot detect a real structure of such complexity. Dr. Bose believed he had indeed found these structures in various plants. The plant will demonstrate a demand capacity at one, two, or even three points. Of these few settings, one will always exceed the others in reactivity. This will then be the major Radionic current required and demanded by the plant. This one setting brings to the plant its primary nutritive need. Flanking this major setting, or "fundamental", there will be a spectrum of weak reactions, or "harmonics". There are always several minor reactive points. Note each of these, writing them down for reference. Test each plant and mark the Radionic positions which each requires.

The plant may not absorb every one of these currents from the capacitor, merely stuttering for a fraction of a second when the current strikes into the plant tissue. Nevertheless, wait and listen for a few seconds at each "stutter point". These may gradually develop into a prolonged audio fluctuation. All of the stutter points which produce these prolonged



fluctuations should be marked on a reference sheet. Try lots of different plants over the next few weeks. See if you can collate the varieties and their Radionic clusters. Do these current points drift? Do they change radically? How do these alterations correspond with plant vitality? Does the appearance of flowers modify the Radionic settings?

#### **EXPERIMENT 4**

The simple tuning system which we have been using permits the manifestation of other fascinating characteristics. Radionic ground currents will flow in either of two directions in a ground rod. Certain tuned currents come out of the capacitor, as demanded by the plant. These produce rising audio pitches. Certain other currents however are drawn from the room into the capacitor and down into the ground. In these strange instances, it is the ground which has demanded a specific pattern current! These down welling currents produce decreasing audio pitches. Through these phenomena we glimpse the mysterious subterranean world and its constant trafficking of messages, an unsuspected world of communications and languages unknown to humankind.

Therefore, we find points from which currents emerge and points into which patterns will flow. Because of this difference in current direction, there will be different kinds of audio fluctuations with which you will soon become familiar. Audio responses differ from point to point on the variable capacitor, marking emergent currents which the plant rejects or demands.

When you now locate points on the dial which produce decreasing audio pitches, you know that the plant is sending its pattern currents back into the ground. These "relaxation points", where the Radionic currents are moving from plant to ground, reveal that currents are actually being drawn from space through the plant INTO the ground! Plants provide pathways for those wondrous currents which flow down from space and enter the ground. Other currents flow out of the ground. In this we also glimpse an unsuspected energetic topography, that which formed the very core of Geomancy. The radionics pioneer, T. G. Hieronymus, appreciated this fact, having designed special "cosmic pipes" for the powerful entunement of Radionic currents from space. These were found to greatly increase the fertility of fields, furthering that new horticultural science earlier produced by Dr. White.

Having slowly swept through the dial, you now should have several current points and their characteristics. Marking the major and minor currents, as well as noting the current directions, will give you the Radionic profile of the plant which you have just examined. List all of these and preserve the data with dates and times. These will prove to be of inestimable importance in later experimental determinations.

## EXPERIMENT 5

Tuned currents which the plant absolutely demands will result in an audio "thrill response". These are noted by both steady "warbling songs" and sudden audio pitch INCREASES. In certain cases, this pitch increase will quickly reach inaudible levels. When this occurs, you have found a major current demanded by the plant. Experimental familiarity will now allow you to expand your knowledge of these things. Obtain a great number of plants, with the goal of individually listing and collating their various Radionic settings.

It was for this reason that I suggested that you obtain ordinary wildflowers. They are plentiful and free! Wildflowers are very hearty and stand up under the shock induced by Biosensors. Some experimenters prefer to purchase plants for their demonstrations. The essential thing is that you obtain a sizable collection of plants. Number each one with a felt-tip marker and keep track of their progress. Keep good notes. Your notebook represents an important document in the re-emerging Qualitative Science.

## EXPERIMENT 6

That plants will actively demand certain Radionic currents may be shown by locating a major current point, and then carefully disconnecting the wire which leads from the capacitor to the plant. Disconnect it FROM THE CAPACITOR FRAME without moving the plant at all. The plant will at once produce a continual "wailing" song, which is really a distress signal. In this, you are observing an appetite demand which will not cease until you have reconnected the plant to its source. Reattaching the capacitor to the plant restores its warbling response once again.

Test other current points in this manner. If your tuner is positioned to draw in a major current, then the plant will respond violently when the wire is withdrawn. Make sure you do not move the plant while disconnecting. Movements will shake the wired leaf and will provoke unwarranted audio fluctuations. The removed connection will provoke either an upward "shriek" or a downward "sigh". In one case, a plant shrieked in such a loud and dramatic manner that I was compelled to reconnect it! When this was done, the plant calmed down and began to "sing".

## EXPERIMENT 7

It is important to recognize that Radionic currents are conducted only at certain rotor positions. This FIXED REFERENCE is enormous in its implications. Having slowly moved the vanes in a continuous sweep, you have found fixed points. That these few fixed points hold their place for each test plant has devastating impact on those who claim the



"subjective" or "mental" view of Radionic Science. If these tuning systems were truly "psychotronic" in nature, then the rotor settings would not retain their fixed position regardless of time.

It is also quite impossible to recall these settings when testing a great number of plants, so that the reappearance of fixed settings becomes an obvious indication of their objective reality. The objective existence of both Radionic currents and the validity of material tuning systems are thus proven. Test these rotor positions several hours or days later. It matters not. You will find that they "hold" in time irregardless of your subjective participation. These fixed points at which Radionic currents are passed by the variable capacitor to the plant, prove their OBJECTIVE EXISTENCE.

## EXPERIMENT 8

If you have performed the outlined experiments, you have already found that the same currents are not shared by all plants. Two plants will respond to two very different capacitor settings. This central fact allows that both currents and plants may be categorized. But now we can compare the Radionic demands of 2 or more plants simultaneously, a most fascinating study.

First open the rotor on your variable capacitor completely. Always begin your examinations from this position. The use of multiple Biosensors permits simultaneous examination of plant songs. Start with 2 plants. Cut a second 6 foot length of thin wire, stripping and attaching its free end to the capacitor frame. Two wire leads should now be attached together at their source. Strip the free end of this second lead wire and drive it into the root system of your second plant. Separate each plant now. They should be perhaps a foot or more apart. Bring this second plant to the opposite side of the ringstand and carefully repeat the leaf clamp procedure.

Each plant should have a selected leaf wired to its own Biosensor. The simultaneous comparison of Radionic differences between each of these plants can now be heard. Turn the Biosensors on and carefully adjust the gain until audio baselines have been established for each plant. Neither rising nor descending, audio baseline pitch may gently drift or simply level off. In a short time, the plant song makes itself heard. Once done, stand back and listen! The entire spectacle is a mystifying wonder, as supposed inanimate plants begin singing and filling the air in a strange otherworldly duet. Each plant is now connected by the roots to the tuning capacitor and will reveal energies which conventional science does not acknowledge.

Stimulated by the vitalizing energies, our own previous personal experience of these energies gives us a fair understanding of what the plants are experiencing. Unable themselves to elucidate on what they are experiencing, we remain limited to the observation of audio pitch changes made as a by-product of their experiential process. A variety of test



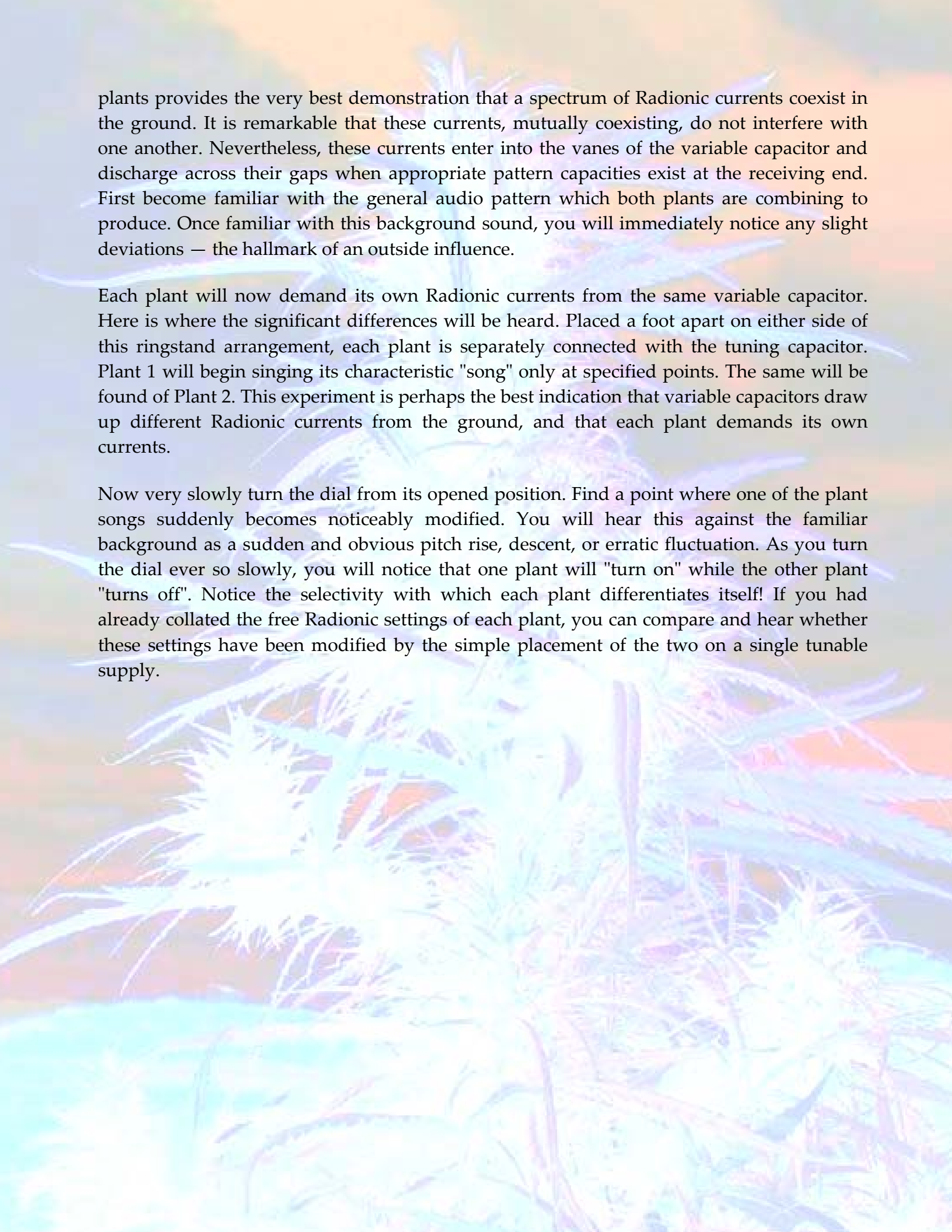

plants provides the very best demonstration that a spectrum of Radionic currents coexist in the ground. It is remarkable that these currents, mutually coexisting, do not interfere with one another. Nevertheless, these currents enter into the vanes of the variable capacitor and discharge across their gaps when appropriate pattern capacities exist at the receiving end. First become familiar with the general audio pattern which both plants are combining to produce. Once familiar with this background sound, you will immediately notice any slight deviations — the hallmark of an outside influence.

Each plant will now demand its own Radionic currents from the same variable capacitor. Here is where the significant differences will be heard. Placed a foot apart on either side of this ringstand arrangement, each plant is separately connected with the tuning capacitor. Plant 1 will begin singing its characteristic "song" only at specified points. The same will be found of Plant 2. This experiment is perhaps the best indication that variable capacitors draw up different Radionic currents from the ground, and that each plant demands its own currents.

Now very slowly turn the dial from its opened position. Find a point where one of the plant songs suddenly becomes noticeably modified. You will hear this against the familiar background as a sudden and obvious pitch rise, descent, or erratic fluctuation. As you turn the dial ever so slowly, you will notice that one plant will "turn on" while the other plant "turns off". Notice the selectivity with which each plant differentiates itself! If you had already collated the free Radionic settings of each plant, you can compare and hear whether these settings have been modified by the simple placement of the two on a single tunable supply.

## SUMMARY

The rich suite of responses with which plants make their utterances is the very basis of many new efforts in Qualitative Science. Validating the controversial aspects of Qualitative Science has now become a priority interest — that priority focusing on Radionics. There may be many whose long and strident belief concerning Radionics has been brought to an abrupt end. Those who are confident that Radionic Currents do not exist, or more specifically, that these currents are products of the mind alone, are shown to be in error.

The "psychotronics" camp has too long attempted the elimination of external energetic controllers — the biodynamic currents. That which the psychotronics view believes are unnecessary props and artifacts, now become the precious components of a New Technology.

In connecting plants directly to the ground by means of wires, we discover the objective reality of Radionic currents. We have proven that these currents are non-electrical, differ among plants, serve as a nutritive need of plants, remain fixed in time, and enhance new responses which cannot be resolved by conventional analysis.

Plants are not autonomous entities. Certainly, botanists do not accept the fact that plants have developed nervous systems. Perhaps they should include the phrase "detectable nervous system". Perhaps certain living things do not require physiological nervous systems when their sensing body is incorporeal.

*\* Editor's note: Unfortunately, Radio Shack has discontinued production of the Micronta Biosensor unit. A very good \$150 unit developed by Buryl Payne may be obtained from PsychoPhysics Labs, 4264 Topsail Ct., Soquel, CA 95073 - Ph. (408) 462-1588. For those who would like to build it themselves, a more sophisticated instrument designed specifically for use with plants is detailed in the article, "Detecting Biodynamic Signals".*

*End of Alon's experiments...*



## Experiments in other extra sensory faculties<sup>1</sup>

I now urge you to have a look at another few very interesting experiments conducted on plants that are shown using a *Flash* presentation in the URL below. It shows clearly that plants are far more advanced in their sensory abilities than many give them credit for. Depending on your PC and its internet setup you may have to wait a little while for the animated experiment to load in.

[http://www.paranormal-investigation.com/research/plant\\_ekg/plant\\_ekg.htm](http://www.paranormal-investigation.com/research/plant_ekg/plant_ekg.htm)

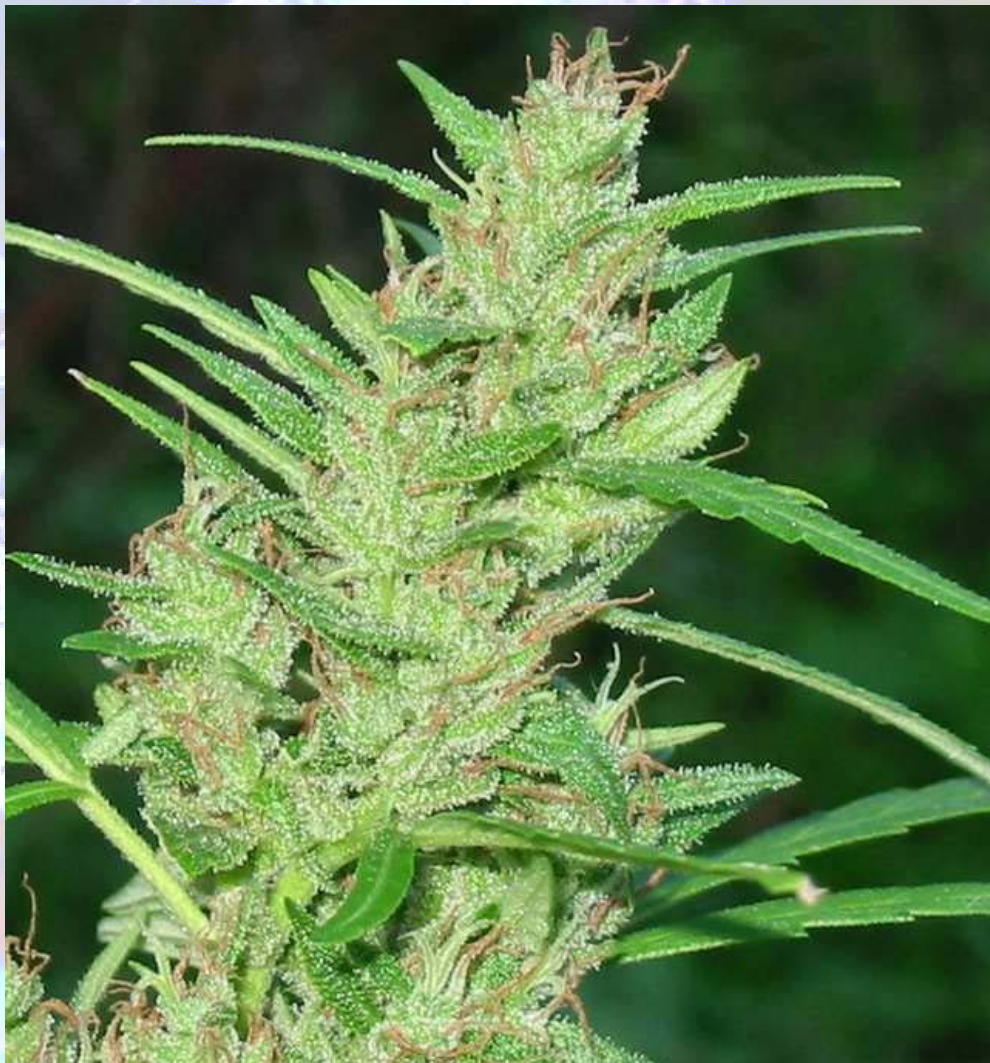

# Building a Radionics Plant Growing Station

Diagrams to help explain the components

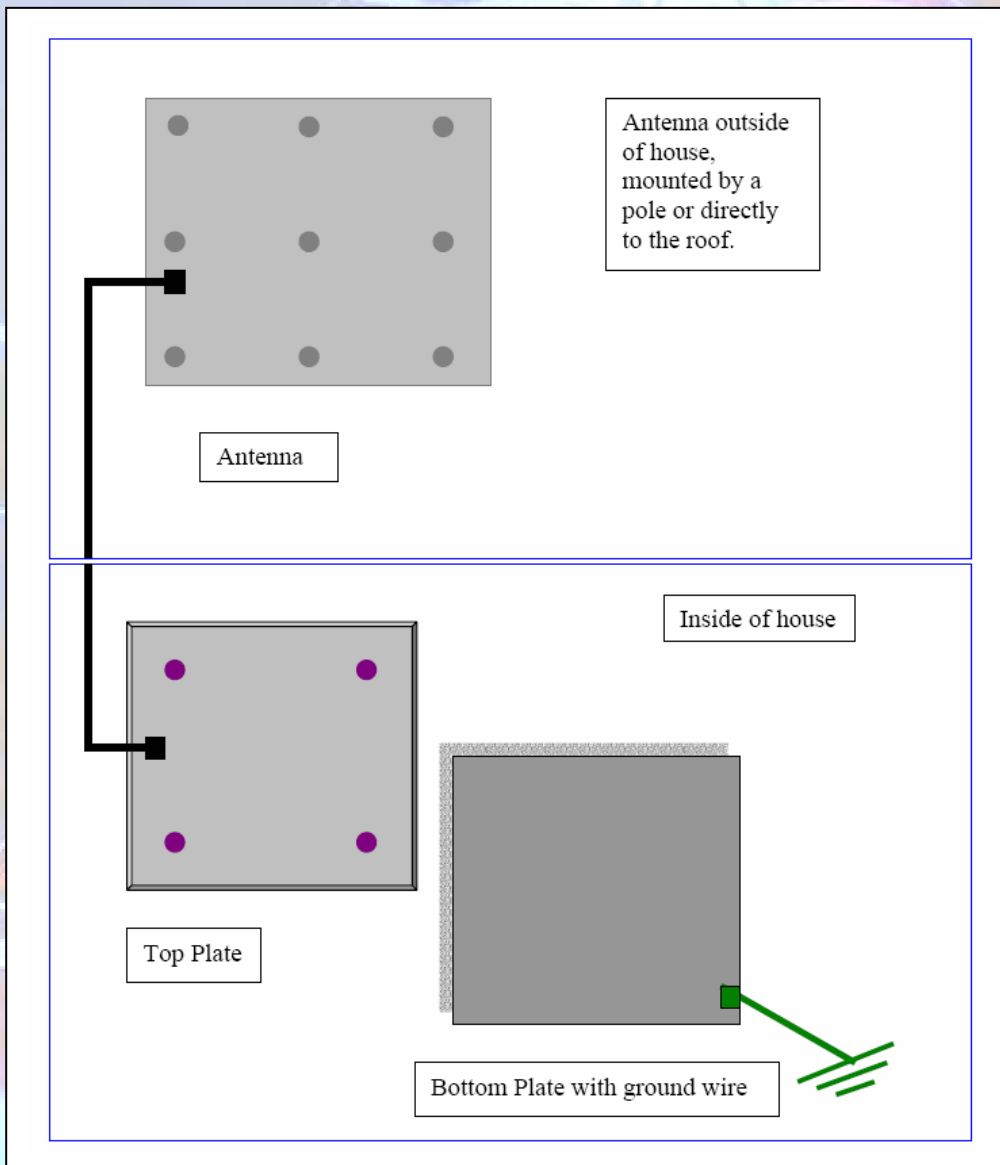



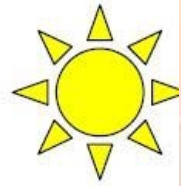

Sun Shines on Antenna collecting Eloptic Energy and passes to Top Plate.

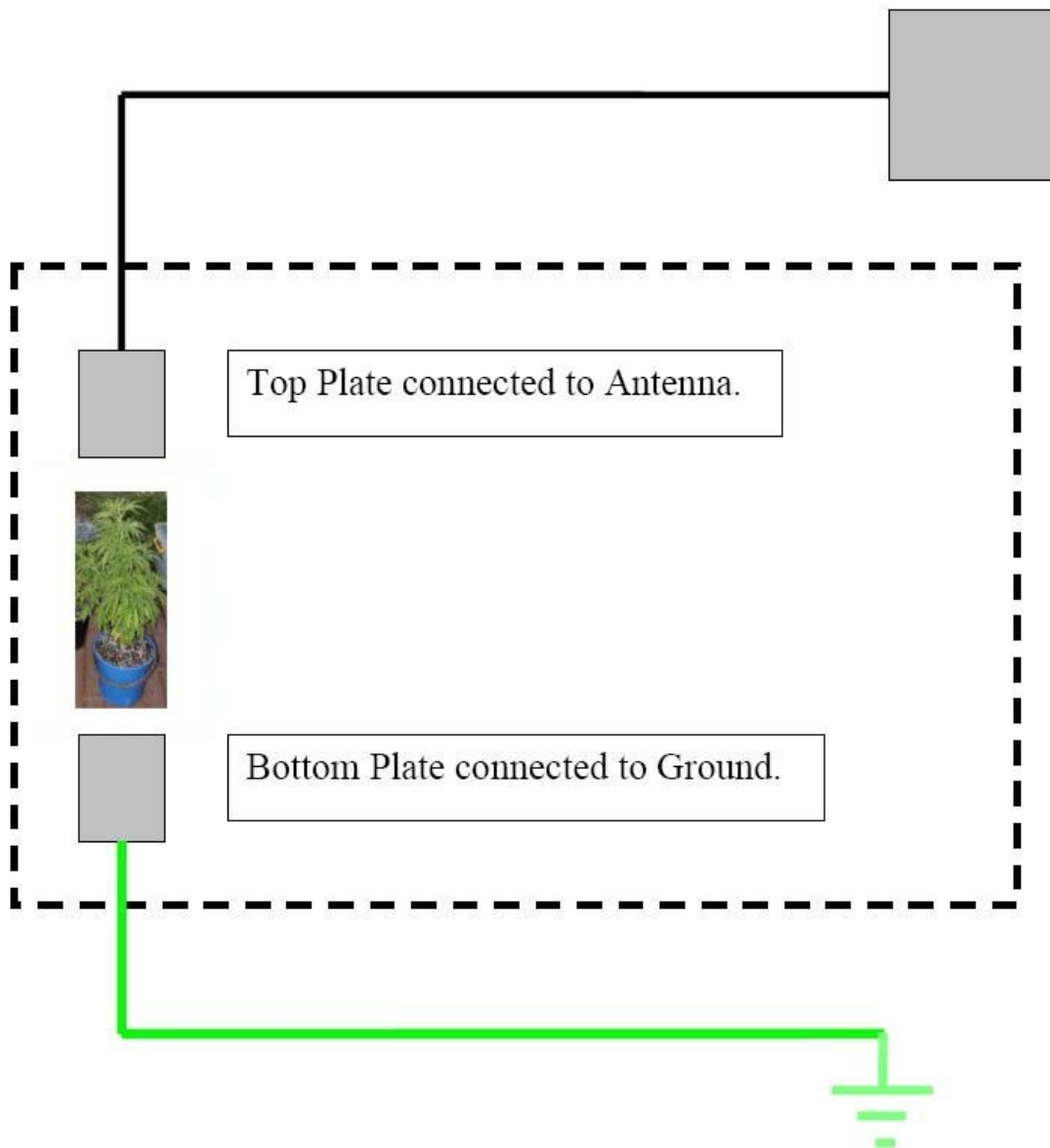

**Black Line is the Coaxial Cable; Black Box is the Ground Block, Circles are mounting spots, Green is Ground Terminal connected to Green Ground Wire to Ground Rod**

## **The Antenna/Collector:**

**One 4' X 4' sheet of Stainless Steel.**

**Thickness is about that of a Dime or .030"**

**Simply mount a Coaxial Ground Block to the SS sheet.**

**Then run the RG coaxial cable to the Top Plate via another Coaxial Ground Block.**

### **The Top Plate:**

**One 4' X 4' sheet of Stainless Steel.**

**Next, cut it in half. Giving you two pieces each 2' X 4'**

**One will be the Top Plate and the other the Bottom Plate.**

**Once you find where you want to place it, simply hang the sheet from the ceiling using screw hooks.**

**Hang the sheet in a Horizontal position, (Flat like the ceiling, not hanging down like the walls.) Keeping about 6 inches between the ceiling and the Top Plate. Connect your RG coaxial cable.**

### **The Bottom Plate:**

**Take the other 2' X 4' piece and set it on the floor.**

**Mount the Ground Terminal to the Bottom Plate and run the ground wire to a ground rod.**

**Please note... if you have a Concrete floor, you still have to ground it. Or it will not function very well. The Bottom Plate has to be grounded to complete the Radionics Wave Station. You may cover the Bottom Plate with a throw rug or piece of carpet to prevent getting hurt from sharp edges. Or you may install a rubber lip/edge around the edge of the sheet; they can be purchased at about any hardware store.**

**If setting up a grow station in a high raised apartment, one may utilize the kitchen sinks metalwork for grounding the station to. It best not to use the earth on the electrical mains as this can and will interfere with the stations efficiency through electrical voltage spikes and leakage currents. An EMF free physical earth is required.**



## Material List

- One Coil of 12 ga. Strained or Solid wire, Green in color. Max Length of 100 feet.
- A Ground Rod.
- One roll of RG Coaxial cable, Max length of 100 feet.
- 10' section of 3" Schedule 40 PVC pipe
- 32" long section of 3" Schedule 40 PVC pipe (if pole mounted.)
- One or Two 3" PVC Flanges (two for roof mounting / one for pole mounting.)
- PVC glue and cleaner
- (1) 3" schedule 40 PVC coupler (if pole mounted.)
- One roll of RG coaxial cable
- One 4' X 8' sheets of Stainless Steel. a. One 4' X 4' (goes outside) b. Two 2' X 4' sheets (goes Indoors) Hardware List...
- (2) Coaxial Ground Blocks.
- (1) Ground Rod Clamp
- (1) 12 ga. Ring Terminal for ground Wire.
- (4) Screw Hooks
- (4) "S" Hooks
- (4) Eye Bolts 8-32 in size
- (4) 8-32 X ¾ inch Bolts
- (5) 8-32 X ½ inch Bolts
- (17) 8-32 Nuts
- (17) Flat Washers for 8-32 in size
- (5) Large Flat Washers for 8-32 in size
- Chain of your choice, four sections 6 inches or longer
- Coaxial cable clamps, for routing RG Coaxial in a neat order. Hand Tools List...
- Wire Striper / Crimper
- Adjustable Pliers
- Phillips & Standard Screwdrivers
- Hand Saw
- Cord/cordless Drill
- One drill bit, 3/16" in Diameter
- Flat File

When connecting the Coaxial cable to any part of the system only the shielding is used and the inner core is left open circuit. When integrating a timing device into the station in an effort to time the station's state from on to off allowing us to provide timing for our nighting cycle etc. All one need do is place the timer's output in between the bottom sheet and earth. This will switch the unit on and off at pre designated times.

**Step One "the Antenna"**

Take the 4' X 4' Stainless Steel sheet and find the center and mark it. Now measure the diameter of your flange. Then split the difference in half for each side of your center mark. Say you have 7" flange, 3 1/2" from all 4 sides of the center mark make another mark. OK you just centered your flange.

Now, place your flange centered on your SS sheet and mark the points for your holes to mount the PVC flange. Next, remove flange and drill out the holes.

Grab your Coaxial Ground Block, is it about 2" long? Center it and placed 2" away from edge, Mark your points for the two holes, remove Coaxial Ground Block and drill out holes. Take a file if you wish and knock down any burrs you may have.

Now, let's mount that Coaxial Ground Block. Using (2) 8-32 bolts, 1/2 inch long along with (2) flat washers and (2) nuts Push bolt thru Coaxial Ground Block and place on SS plate, then on back side of SS plate place flat washer and tighten with nut, using pliers and screwdriver. Make sure it is good and tight.



Now back to the PVC flange, using (4) 8-32 bolts, 3/4" long, (4) large flat washers, (4) flat washers and (4) nuts. We will mount the PVC flange. Place a large flat washer over bolt, and then push thru PVC flange.

Now place PVC flange on SS sheet with bolt thru the hole, on the other side, take flat washer and tighten nut securely. Repeat three more times.



Your antenna is almost complete.



## Step Two "the Top Plate"

Now the Top Plate is a little easier, just more hardware to install. Let's start by marking for our holes. Measure 3" in on each corner and mark a spot. Repeat for each corner, for this is where the eye bolts go for hanging. Next, measure your Coaxial Ground Block, about 2"? Measure 2" in from edge and center Coaxial Ground Block to SS sheet. Now mark the two holes.



OK! Grab your drill and make those 6 holes, you may file away any burrs. Get that Coaxial Ground Block and mount it just as on the Antenna. Using 8-32 X 1/2" bolts thru Coaxial Ground Block, push into SS Top Plate and on back side, place your flat washer and tighten nut securely.



Next are the eye bolts, first place nut all the way up threads, then a flat washer, now push eye bolt thru SS sheet, on back side place another flat washer and nut. Ready? Tighten the nut you placed first, down to the SS sheet and snug the nuts up against each other, leaving the bolt just going past bottom nut to make a neat appearance. Repeat three more times.

You are half way there...

### Step Three “the Bottom Plate”

The easiest part to complete, I promise. Take the other 2' X 4' SS sheet and drill one for the Ground Wire Ring Terminal. I placed mine 2" in from the edge, centered at 12 inches. Grab your 12 Ga. Green copper strained roll of wire, strip back about ¼" of the green wire jacket and then crimp the Ring Terminal on to the end of the wire. Using (1) Large Flat Washer, (1) Flat Washer and (1) Nut and (1) 8-32 X ½" Bolt, place a flat washer on the bolt, next the Ring Terminal, then push thru the SS sheet, and on the back side place a Large Flat Washer and Nut. Tighten securely.



### Step Four “the Ground Rod”

Run the green ground wire to the outside of your home. Using a sledge hammer beat the ground rod into the ground, at the point where your green wire is. With the brass ground clamp, mount the clamp to the ground rod and then your green ground wire. Make sure the clamp and wire nut is tight.



**The Bottom Plate is Now COMPLETE.**



## Step Five “the PVC pole”

You may use another PVC flange and anchor it to the roof with a 3” PVC pipe cut at 18” long. Using PVC Cement, glue the pipe to both flanges and your antenna is up. Connect your RG Coaxial Cable and route it to the Top Plate inside your home, and ensure both connectors are snug.



**OR**

You may mount on a PVC pipe 10' long.

First by gluing the Antenna to the PVC pipe and then by mounting pipe into ground base.

## Step Five A "the PVC pole with Base"

Take one bag Quick Crete type cement.

Dig a hole about 6" to 8" inches in diameter and about 2 feet deep.

Concrete in a 3" joint of PVC pipe that comes flush to the surface.

Note... you may want to drive a metal bar inside of pipe to help secure it while pouring concrete around it. Let concrete cure... While you are waiting, take (1) 3" coupler and drill 3 evenly spaced holes into it about 1' from edge or so.

Now take your 3" PVC coupler, making sure the 3 holes are up and glue that onto the 3" pipe you concreted in. When the concrete has setup, take your antenna pole, connect RG Coaxial Cable to Coaxial Ground Block and then place into 3" coupler.



Force down all the way. Using 3 Sheet metal screws, to secure your PVC pipe to the Base, thus a movable antenna or you may glue in for a more permanent antenna. You can use tie wraps to hold coaxial cable to the pole.



And here is a picture of the Hardware Used:



You can vary your Antenna Size to what ever will work for you.

Please note... as you change Antenna Size, you change focus point and that affects Plate Size and the space between the two Plates. **Also your Antenna has to be a minimum of 6 feet above the ground to work, closer then that and you will not get the flow of energy you desire.** This is why we recommend mounting on the roof or mounting on a 3" PVC pole as pictured.

*Table 1*

Antenna Size	Plate Size	Antenna Height to Space	Between Plates
4' X 4'	3' x 3' / 2' x 4'	Less then 6' tall	16" or less
3' X 3'	2' X 2'	Over 6', Less then 10'	48" or less
2' X 2'	1' X 1'	10' tall	72" or less
		10' tall or Greater	72" or 75% of Antenna height

**This chart is given to find optimum focus and flow of life energy. You may have to fine tune the plates by raising or lowering the Top Plate from the Bottom Plate.** To Use with a massage table, simply mount Bottom Plate to the underside and route ground wire as needed. You can fashion a hanging post from metal conduit, PVC pipe, or modify a lamp, for the Top Plate and likewise with the Antenna.

**Do NOT** bring large metal items into the beam area, this will disrupt the even flow and build small pockets of neutral areas. (Like getting a sun tan and having a tan line where your watch is.) Plus it will introduce a restriction in flow and reduce the capability and efficiency of your Radionics Wave Station.

## Growing Cannabis using a Radionics station

The most important factors in understanding how to set up your own Radionics Grow Station can be found in **Table 1** outlined in the previous section and below. It is the key to working out what size Stainless Steel sheets to use and how far above ground level one must place their external antenna for efficient operation. It should also be mentioned that any flat shiny ferrous metal sheets can be used other than Stainless Steel, such as tinned or galvanized mild steel sheets, but they will in time begin to rust and render the station far less efficient. As will any foreign matter that collects or falls onto the antennas upper surface including leaf, thickly accumulated dust or bird droppings. Keeping the top working side of the entire Stainless Steel antenna plates clean and free of debris will be the **ONLY** maintenance ever required on the station during its entire working life.

In helping you understand **Table1** and how to use it in determining the best way to configure your grow area there are 3 examples outlined below that utilize the configuration of the three main sheet sizes mentioned. It best to cover all three classes of indoor growing which are Sativa biased ScrOG grows, Indica biased ScrOG grows and commercial type SOG grows. Keeping in mind that these are only examples which can be altered to whatever configuration one chooses depending on their needs and or preferences. Also worth mentioning is that the grow room/volumes represented are not necessarily the total bounds of the grow space or cabinet and one must make allowances for this. Like fans, scrubbers and the like that would be mounted within and around the bounds of the represented grow volume.

**Table 1** has been conveniently laid out to cover each individual class of grow as follows:

Antenna Size	Plate Size	Antenna Height to Space	Between Plates
4' X 4'	3' x 3' / 2' x 4'	Less then 6' tall	16" or less <b>SOG</b>
3' X 3'	2' X 2'	Over 6', Less then 10'	48" or less <b>Indica ScrOG</b>
2' X 2'	1' X 1'	10' tall	72" or less <b>Sativa ScrOG</b>
		10' tall or Greater	72" or 75% of Antenna height

In a grow space of 2.1m x 1.3m x 0.8m we can use the following to convert the small room into any of the three classes of growing by configuring it as follows:



# SOG grows

## SOG biased small Radionics growroom 2.1m x 1.3m x 0.8m

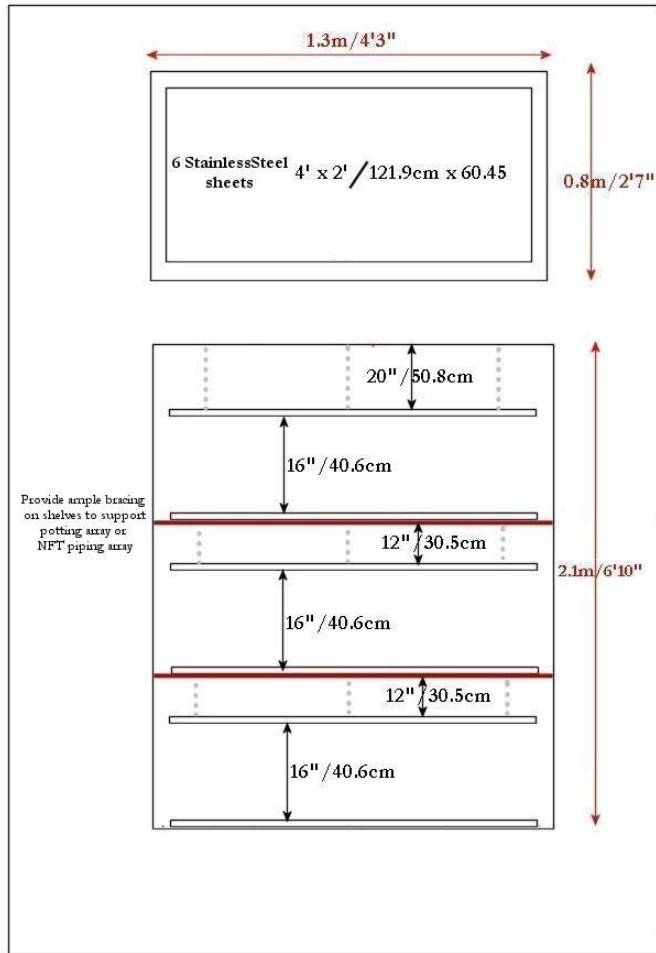

The level of the outdoor ground MUST be equal with or lower than the level that the base/earthing sheets are placed on the floor of the growroom

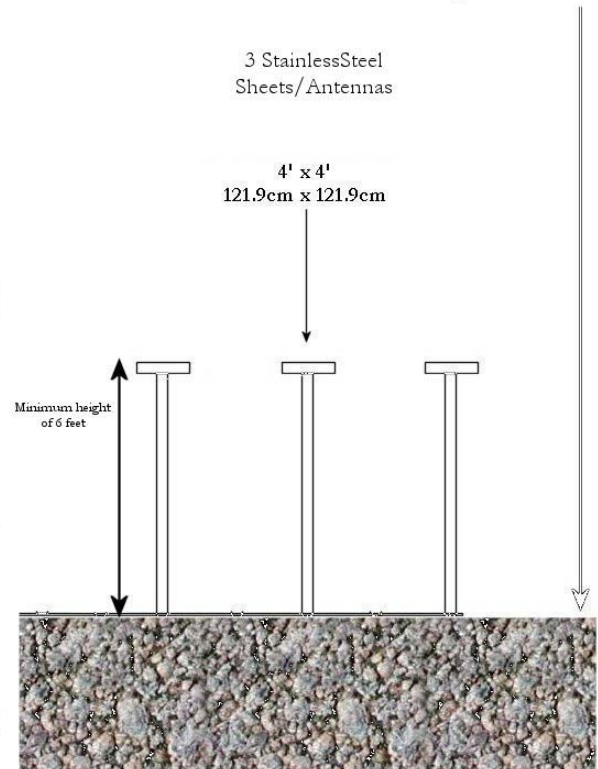

With a spacing of 4 plants per square foot at a total of 48 plants, this will effectively allow us to produce 48 x 1foot tall colas of dense indica bud weighing approximately 1oz each. Giving us a total of 48oz or 3lbs of primo dried bud per harvest.

# Indica biased ScrOG grow

## Indica biased small Radionics Grow Room

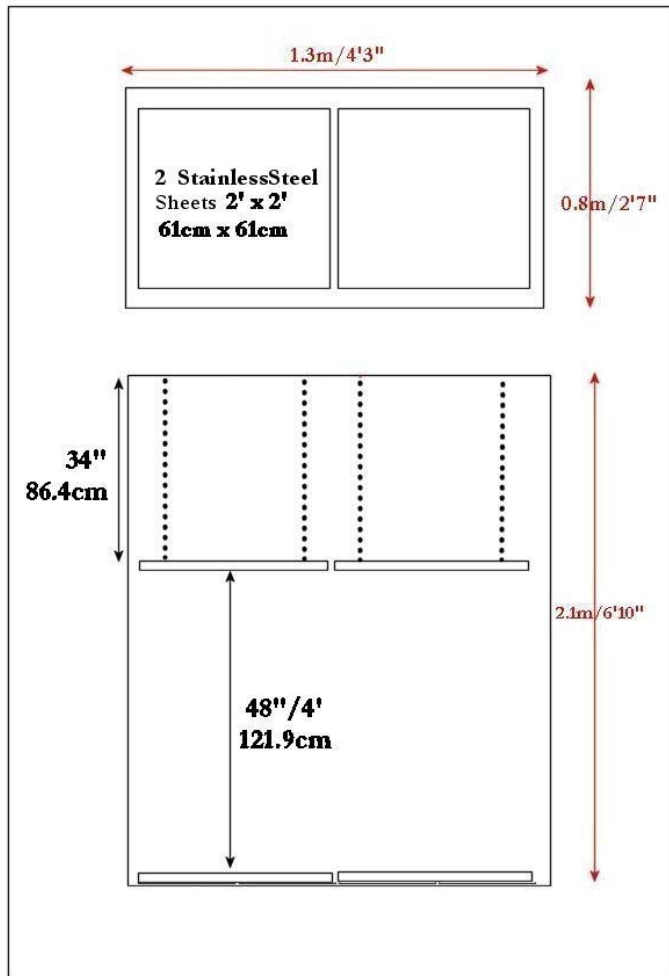

The level of the outdoor ground **MUST** be equal with or lower than the level that the base/earthing sheets are placed on the floor of the growroom

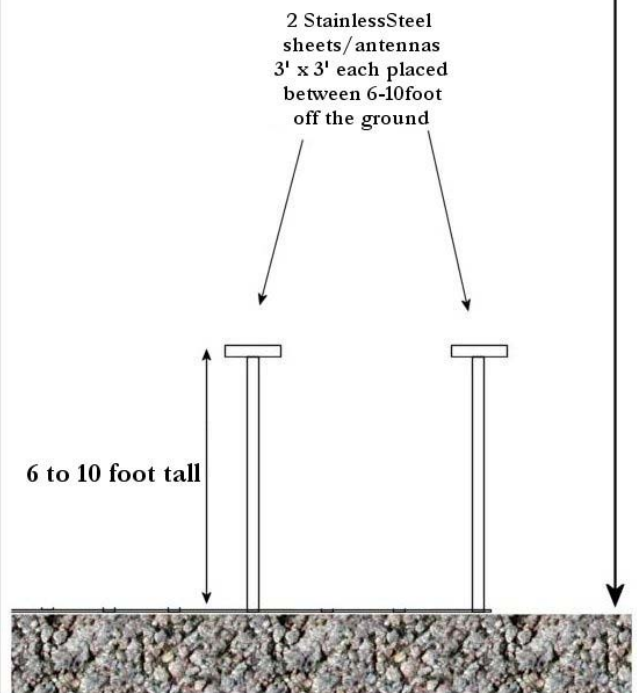

With 2 cloned plants in total branched heavily and kept low in veg this will effectively allow us to produce dense indica bud quickly with a minimal of vegging yielding an approximate total of up to 500g/sq. meter. With an approximate grow area of 1.04m<sup>2</sup> one can expect around 500g of bud per harvest.



# Sativa biased ScrOG grow

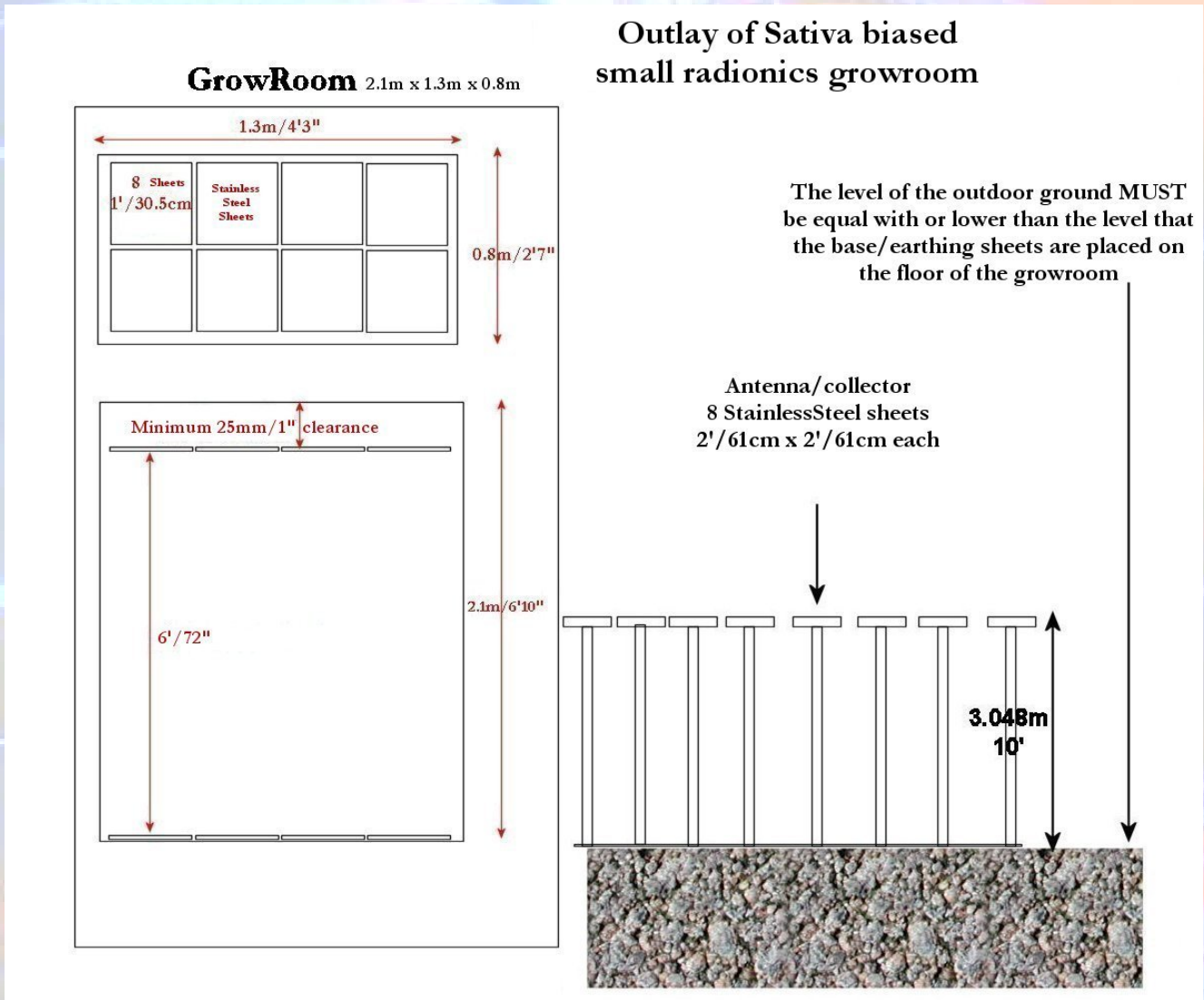

This configuration can in fact be used for both sativa and Indica biased genepools if one doesn't mind vegging their Indica for a longer period of time to attain the full height on the grow volume when finished. In sativa grows one could even grow a long stretching Landrace sativa if flowered from day 1 without having to crop the top to restrain its height.

With 1 or 2 cloned good yielding Sativa plants branched heavily without any vegging photoperiod this will effectively allow us to produce quality lambsbread clusters yielding an approximate total of 500g/sq. meter – strain dependant. With an approximate grow area of 1.04m<sup>2</sup> one can expect around 500g of bud per harvest.

## Advantages of growing plants using Radionics

- The obvious advantages are that of eliminating the need for costly lighting gear and running costs, and that in itself is of major benefit.
- We are also able to eliminate heat buildups in and around our grow volume from the absence of light and from the light tubes running gear.
- We gain free space within a small grow spaces due to lack of light tubes, reflectors and running gear.
- We eliminate being detected by authorities using Infra Red cameras and other heat seeking devices used in the apprehension of HID grow rooms within buildings.
- Once setup, a Radionic Grow Station increases our grow efficiency in terms of costs per gram produced, due to the elimination of HIDs purchase and running costs as well as their lamp consumable costs with every second or third grow requiring new lamps.
- Never having to cover up windows for a long period to conceal internal light emissions results in increased stealth of grow to nosy neighbors and onlookers.
- Maintaining constant ideal grow room temperatures throughout the plant's entire life is much easier and cheaper in terms of electricity used to do so when compared to a HID environment.
- Abolishing the emission of high levels of EMF transmissions around the grow room in the home which the HIDs running gear produces is beneficial to our health.
- Accidents caused by accidentally striking discharge tubes whilst they're on or droplets of water causing them to explode are eliminated.
- Risk of electrocution from the HID and its running gear is eliminated.

There are other advantages in using the normal Radionics stations that are sold for holistic healing purposes that I haven't touched on yet.

- These include the **safe** application of deadly and powerful insecticides which we would normally never even consider via emitting the appropriate signatory signals of these chemicals onto the entire surface area of the plants without ever having to touch the plants physically with the chemicals in question. The effect on the plant would be identical as though having applied them onto it physically, but without the contaminating issues associates with it. For instance, place a small amount of the chemical in one of the station's **wells**, a small piece of the plant you simply cut off it



with scissors into the other **well**, tune them to their appropriate frequencies, and initiate the transfer of vital energy through the air in the grow area.

- Theoretically, the same should work when using any and all substances we normally physically apply. Including liquid fertilizers to the roots, foliar feeding without spraying, application of any form of liquid to the roots for any purpose including watering may be achievable once we have mastered the use of a standard Radionic station. The applications are near limitless.

A grower in the States controlled spider mite infestation in his grow room filled with THSeeds's HeavyDutyFruity clones by placing a small amount of Pyrethrum in one of his station's wells, and a piece of leaf from the plants in his grow in the other 'sample well' of his station, and then making the appropriate frequency adjustments and initiating the process. Within a day or two he noticed them disappearing at a fast rate and after 2 weeks they are almost totally gone. All this without ever having sprayed anything onto the plants themselves, simply by bombarding them with the correct frequency produced by the substance that eliminates them upon physical application.

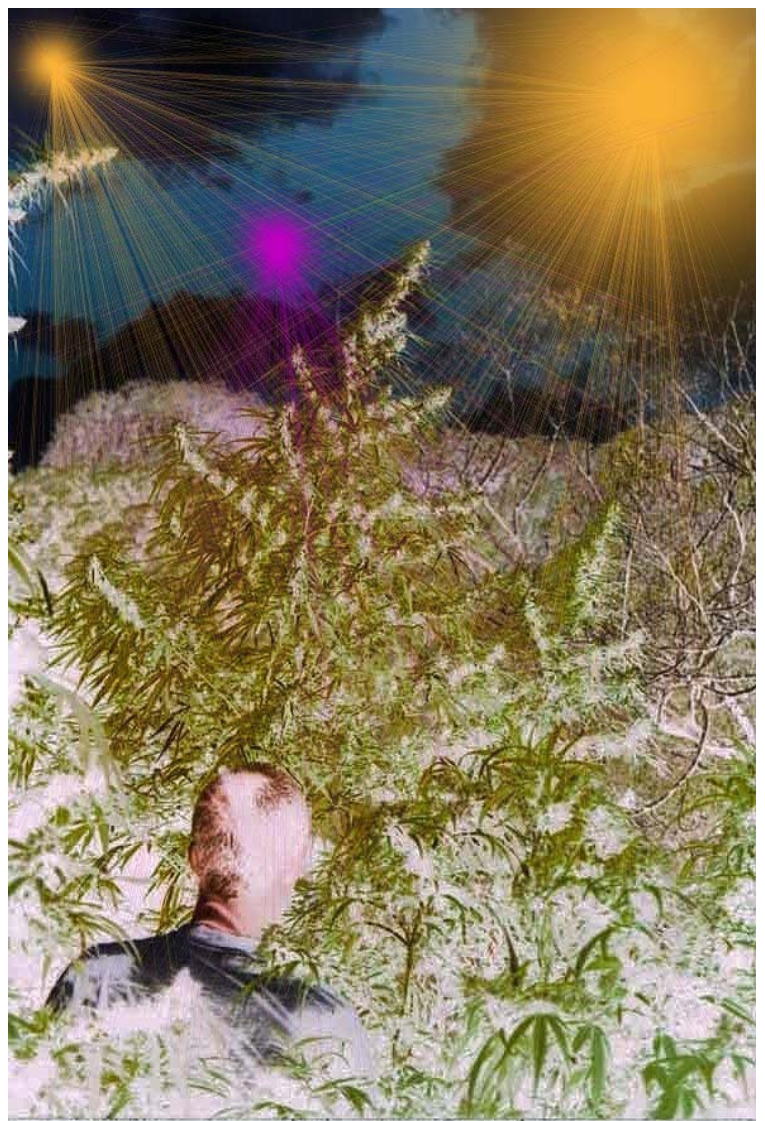



## Conclusion

It is my firm belief that radionics is the 'missing link' in our current (miss) understandings of Electromagnetism which Nicola Tesla often warned the world about. It was because of his natural ability to understand it clearly that allowed him to achieve his phenomenal works that many others stole and claimed their own. Though it was his remaining works that had the most significance. These were denied by authorities of the time and to date, because of their ability to create '**something for nothing**', even though we are told from the cradle to the grave that we can never have 'something for nothing'. It is the latter which all existing sciences embrace and which Tesla proved to be **completely erroneous**. When we can understand the *Radionic essence* of Electromagnetism, then we can easily create many things for and or out of nothing, and Tesla conclusively proved just that in his lifetime of lesser known achievements that are hidden from mainstream public to this day.

I feel the reason he never explained what the essence of the flaws of current electromagnetic principles were, was in fear of being ridiculed and perhaps even branded insane by the lesser knowing and appallingly educated people of his time, which in those days may have even landed him a jail sentence, or at best a term in a mental asylum. Without prejudice, Nicola Tesla was in reality the genius's genius. He was in my opinion the most intelligent human being ever to have lived on our planet – by far. The total works of Einstein, Franklin and Newton put together were of lesser significance when compared to the works of this handsome, highly spirited and cultured natural genius of Serbian origin. It has been said by many that because he was not of the supposed 'right bloodlines', as were all other recognized supposed geniuses the world's known in recent times including the three pre mentioned scientists, that his true status was suppressed from the public's eye. It should also be mentioned that many believe that Tesla was not the only true genius in this world to have undergone such denial in their days by those same powers for the same reason, and to the complete and utter detriment of mankind.

It is generally accepted that the human body along with all living and non-living matter have their own unique energy field around them. This belief is held even without the proof of science, although VAST research is being conducted both openly and under secrecy in this field.

A small group of people believe that this energy can be conducted along a wire or conductor into a device which will allow measurement in a subjective manner that is by using the human body response to this energy to determine a result. Generally without indication of the intensity of energy, information is determined by 'frequency' changes of this energy. Radionics is the utilization of an unusual energy or form of energy to produce desired effects.

The energy is PRE PHYSICAL, in that it is the force field around matter, thus detection, tuning, and transmission comprise the art of radionics. The energy itself has two polarities



which are **spirally twined together**, or may exist separate. These energies may divide into two more which are generally locked into matter.

I believe radionics to be directly linked to the **signatory resonant harmonic vital energies or frequencies** which **all matter emits** throughout the entire universe. This frequency being of an *electromagnetic essence* is capable of dividing itself back into the primary 'base or fundamental' frequency which pervades all known and unknown universes, dimensions and time continuums in all existences. Without it, there is absolute nothingness; no matter, no space, no time – absolute void. It exists only where time exists, for without time, there can be no frequency of any sort; therefore it can be said that Radionic waves are the fundamental signatory energies of all that exists in all and any realities. Without them, there can be no reality of any sort; yet we, as supposed intelligent beings, know almost nothing about them. To cohesively 'consolidate and ensure' our transition as a race of beings to their next level of evolutionary higher consciousness, we must begin to seriously look at and thoroughly understand all principles of Radionics; their existence, their quantification, their transfer and their integrative effects on each other. Once having done so we will have also created a new form of science which will encompass principles of mathematics, physics and chemistry which we know nothing about today. It is and will be 'the true Science' which has been cloaked from the public for far too long.

Once exposed and mastered, the creation of **something out of nothingness** will be child's play for all. The existence of 'control' over other humans shall have no bearing. Monetary economies shall be a thing of the past. Immortality will easily be achieved, hence dissolving the need for **any and all** religions the world over. This in itself will eradicate the existence of any future wars on this planet involving its indigenous inhabitants against one and other. A truly 'utopian existence' would not be deemed as a mere wishful thought of an extreme optimist.

I firmly believe that **Radionics is the key to the relentless pursuit of knowledge absolute**. It is the same pursuit that the so called spiritual opposing forces, God and Satan, have been in struggle over since their supposed conception. With one entity opting to use constructive means to achieve it, the other destructive. Which is a subliminal representation of both aspects of the human demeanor in its quest for such an ultimate realm. Not only have such supposed celestial beings been in total pursuit of such power absolute, but so have many humans since the beginning of time. I believe it to be there **for us all to share**, if and when we see fit to do so *collectively*.

A clear indication of the awesome power of Radionics can be seen in the simple work we have conducted allowing us to grow sun loving plants in complete darkness. If we can harness and transfer the Sun's energy into complete darkness using **the most basic** principles of Radionics, that are equivalent in complexity as mathematically adding two numbers together, then nothing is impossible once we have Mastered it's most advanced Laws. Matter, time and space shall have whatever meaning we wish them to have. Instantaneous travel without vessels of any sort across galactic distances throughout our entire universes will be but a thought away. The principle of operation of such ideology would be to simply know the exact **signatory complex Radionic frequency** of a spot on a distant planet which we wish to travel to. Then by providing the matching signal to 'it' through our bodies using *multiple mentalism*<sup>2</sup>, we would be instantaneously 'telepathically-ported or to be more precise, '**mentalismically-multiple-matched**' to that exact location instantaneously.

Thereby proving that  $E \neq mc^2$  ...but rather  $E = m\infty^2$  ...therefore  $E = \infty$

Which makes a lot more sense as it then places no restriction on our rate of travel, and more importantly it defines the **full potential energy** of any matter as being equally proportional to any other, whilst simultaneously being of immeasurable magnitude **irrespective of its mass**. Hence providing no differentiation between any matter's potential energy, but simply that they are all individually infinitesimal in their magnitude, as though they were all simultaneously combined even though they're physically apart. This will also consolidate the *Theory of Universal Oneness* mathematically; an unachievable feat using existing sciences. 'All this' and we are only at the **tip of the iceberg's tip** so far as the overall picture of the complete Radionics realm is concern.

Mankind's **eternal existence and true freedom** will have finally been **secured** out of what we know today as a type of 'obscurity'. It always has been through the unknown or forgotten door which opportunity presents itself. Anyone taking the subject of Radionics in a light manner, or not believing in it at all, may get it right in another lifetime. There are many things in life we cannot comprehend, yet we know they exist. Simply because we cannot as individuals comprehend them, is no reason to completely deny and certainly not to forbid them. As with all truths, if left alone in time irrespective of how well hidden they are, they will come forth and reveal themselves in due course; Radionics is no exception.

**20'Thai**